



MEDICAL REFRIGERATORS



PSR600

PSR1200

PGR600

PGR1200

USER INSTRUCTIONS

Contents

Installation

3.....	Technical Data
4.....	Positioning and Location
4.....	Accessories
5.....	Electrical Connection
5.....	Starting Up
6.....	Safety Notes
6.....	Cleaning and Maintenance
6.....	Important Storage Advice

Controller

7.....	Overview / Button Functions
8.....	User Options Menu
9.....	User Settings Menu
10.....	Alarms & Error Messages
11.....	Alarm History
12.....	Power Failure

Other

13.....	Internal Light
13.....	Remote Alarm Terminals
13.....	Internal Fan
14.....	Defrosting
14.....	Back Up Battery
14.....	Access Port
15.....	Troubleshooting
15.....	Disposal
16.....	Contacting customer service

Technical Data

	PSR600	PSR1200	PGR600	PGR1200
Unpacked Dimensions (H x W x D mm)	1995 x 690 x 840	1995 x 1330 x 840	1995 x 690 x 840	1995 x 1330 x 840
Unpacked Weight	140	200	140	200
Max weight loading per shelf	25			
Voltage	230V	230V	230V	230V
Frequency	50Hz	50Hz	50Hz	50Hz
Power (Watts)	350	600	350	600
Fuse Rating (Amps)	13	13	13	13
Overvoltage Category	II	II	II	II
Refrigerant Type	R134a	R134a	R134a	R134a
Refrigerant Qty (grams)	280	320	280	320
Max Operating Altitude (Metres)	2000	2000	2000	2000
Max Humidity	<70% at 32°C	<70% at 32°C	<70% at 32°C	<70% at 32°C
Pollution Degree	2	2	2	2
Sensor Type Control / Display	NTC10K, 10000Ω @ 25°C	NTC10K, 10000Ω @ 25°C	NTC10K, 10000Ω @ 25°C	NTC10K, 10000Ω @ 25°C
Accuracy (Load / Air Display)	± 0.3°C	± 0.3°C	± 0.3°C	± 0.3°C

General Information

Your appliance is suitable for the storage of pharmaceuticals and other material which requires a storage temperature between +2°C and +8°C. The range of ambient temperatures that your appliance is designed to operate safely in are detailed in the table below.

Model Number	Minimum Ambient Temperature	Maximum Ambient Temperature
PSR600	10°C	38°C
PSR1200	10°C	38°C
PGR600	10°C	32°C
PGR1200	10°C	32°C

Ensure that your appliance is not operating in a location that may exceed these minimum or maximum values.

After you have received your appliance, inspect the packaging carefully for any damage that may have occurred during shipping. Immediately report any damage to Lec Medical, see page 18 for contact details.

Before using the unit, read these operating instructions carefully, including all the information on operating safety, use and maintenance.

Positioning and Location

Remove all packaging including strips of adhesive tape, plastic bags and pieces of packing foam from inside the cabinet.

The unit must be set up in a dry well ventilated place. Avoid locating the unit in direct sunlight or close to heat sources such as radiators

Air must be allowed to circulate freely around the appliance. Make sure there is adequate ventilation all around the cabinet, ensuring there is gap of 50mm around the sides, 75mm at the rear and 25mm at the top.

Avoid locating the unit directly below a ceiling fan or right next to air-conditioning equipment.

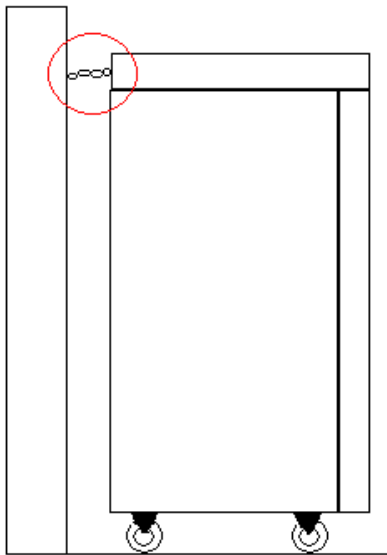

Make sure the unit is level

Once in position, the front castors should be locked

All models are supplied with fixing chains in order to anchor the units to the wall. Fix the chains to the rear of the refrigerator using the bolts supplied and then fix the chains to the wall using appropriate fixings.

Failure to comply with the requirements above may invalidate your warranty and you may be charged for a service call.

Accessories

The following accessories are supplied in a bag inside the appliance:

- User instructions
- 1 x USB memory stick containing "The Heart" software package
- 2 x Power switch keys
- 1 x USB cover to protect the USB drive on the front of the appliance
- 2 x plastic caps used to seal the access port if you are using your own monitoring probe
- 1 x Set of wall fixing chains
-

If any of the above should be missing, please contact after sales service immediately.

Electrical Connection

If the refrigerator's voltage rating does not match your electrical supply, or if the plug on the power cord does not fit the outlet, **do not plug the refrigerator in**. Contact your supervisor, safety officer, or qualified service or electrical engineer.



THIS APPLIANCE MUST BE EARTHED

To prevent problems with other electrical equipment causing this unit to malfunction, it should be connected to a separate circuit. Never connect the unit to a single socket with other electrical equipment by use of a multi-socket.

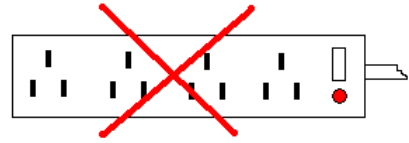

Make sure that the plug is easily accessible so that it can be easily disconnected without having to move other equipment or furniture.

ELECTRIC PLUG WIRING (UK ONLY)

The wires in the mains lead are coloured in accordance with the following code:

GREEN AND YELLOW - EARTH
BLUE – NEUTRAL
BROWN – LIVE

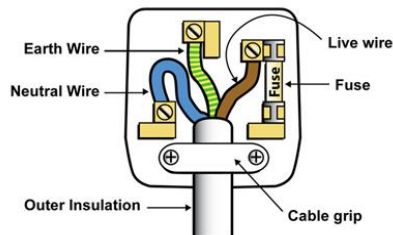

Starting Up

Once positioned, allow the appliance to stand for at least 2 hours before first switching on, in order for the refrigerant to settle.

Once the appliance has been left to settle as above, plug the unit into the mains and switch on at the plug.

The key switch on the rear of the appliance must then be turned to the “ON” position – it is advisable to remove the key from the switch and keep it in a safe place, as it will be required during future maintenance visits etc.

After turning the key switch to “ON”, the internal temperature will be displayed after a short period and the refrigerator will begin cooling.

The temperature controller will alarm whilst the refrigerator is cooling down to the correct temperature.

Silence the audible alarm by pressing the mute button  on the controller. The alarm will continue to sound every 15 minutes until the appliance has reached the correct operating temperature.

When first starting up the appliance, the “BATTERY LOW” message may appear. The message will disappear as soon as the battery is charged.

Run the appliance for 24 hours before loading with products, in order to ensure that it is working correctly, and is operating consistently between +2°C and +8°C.

Safety Notes

Ensure that users familiarise themselves with the user instructions. Failure to install and operate the appliance according to these instructions may result in harm to the operator, or the contents being stored.

This appliance must only be used by adults. Do not allow children to play with the appliance or touch the controls.



All installation work and adjustments to the unit must only be carried out by qualified personnel. Work performed by persons with insufficient technical knowledge may adversely affect the performance of the unit, cause damage to the equipment, or cause physical injury to the user.

Users should not remove any panel with this label attached, as there may be access to live electrical components. Only trained service technicians should remove these panels for service or repair purposes.

All servicing and repairs must only be carried out by a qualified customer service engineer. Only genuine spare parts must be used.

Ensure that the connecting cable is not squeezed or bent when the unit is being installed or moved.

Before cleaning or carrying out maintenance work, always switch the machine off and disconnect the mains plug. Always pull the plug and never the cable.

The unit's cooling system contains refrigerant. Both the unit and the products stored inside can be severely damaged if this system starts to leak. Make sure, therefore, that no sharp or pointed objects come into contact with the cooling system, which is located at the back of the unit.

Do not store flammable or explosive substances in the appliance – THIS APPLIANCE IS NOT SPARK FREE.

Failure to comply with the requirements above may invalidate your warranty and you may be charged for a service call.

Cleaning & Maintenance

The refrigerator should be cleaned and if necessary disinfected before you use it for the first time and at regular intervals thereafter.

Use only gentle cleaning agents. Never use aggressive or caustic cleaning agents, scouring powder, steel wool, abrasive sponges or chemical solvents. When cleaning, make sure that no fluids of any kind run into the ventilation housing.

Be sure to treat the door seal on the appliance with great care. Avoid damaging this seal in any way, as the refrigerator cannot operate properly with a defective seal. Once each month, it is advisable to wipe both the seal and the surface against which it seals with a soft dry cloth.

It is recommended that your appliance is serviced and calibrated annually by a qualified technician. Please contact customer care for advice.

Important Storage advice

Do not overfill the appliance with product

Only store items on the shelves provided

Store items tidily and allow for air to circulate around

Make sure that stored items do not touch the reference bottle or the air sensor.



The maximum weight load per shelf is 25kgs

Temperature Controller

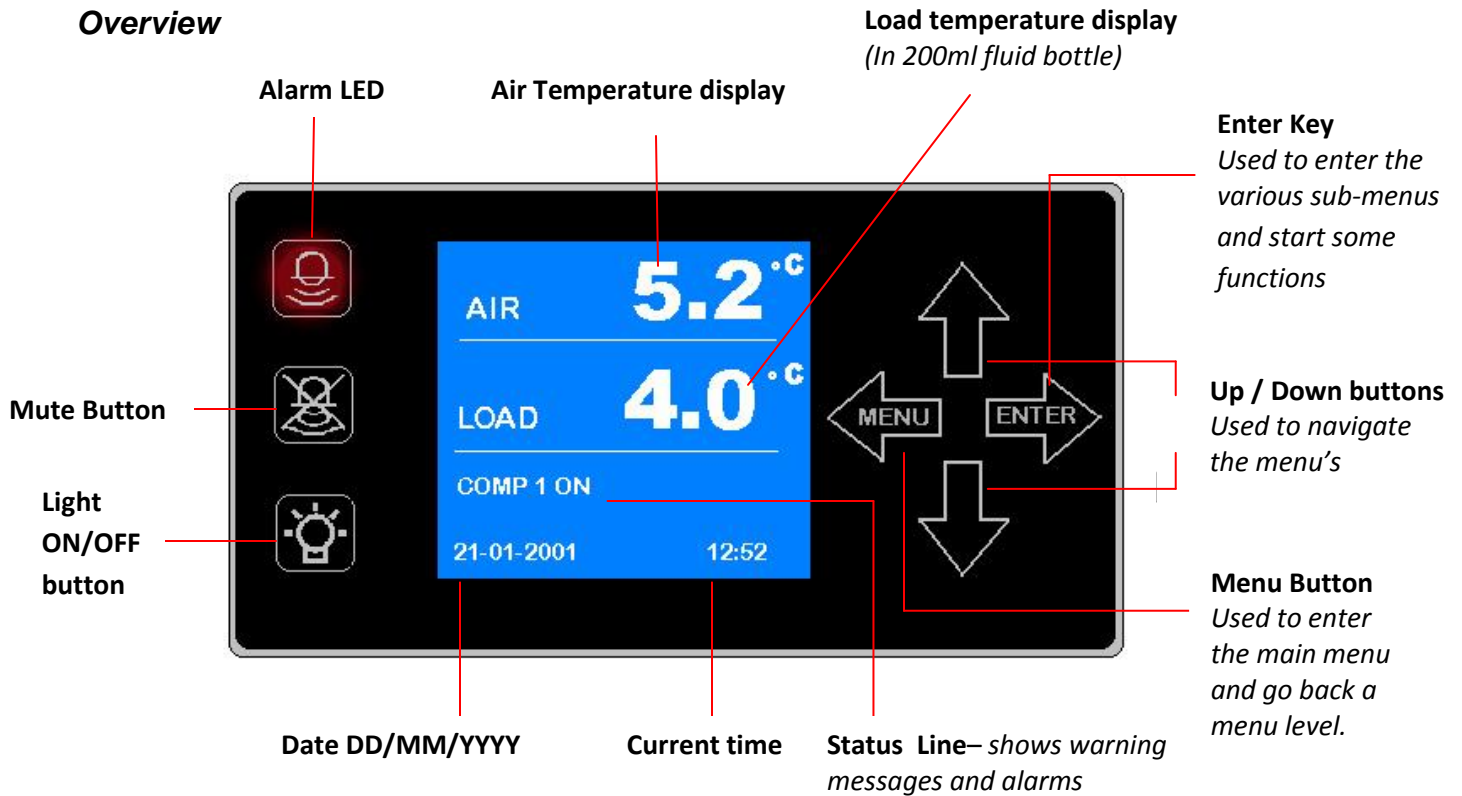
Overview



Button Functions

The controller has 2 buttons on the left hand side and 4 buttons on the right hand side. The 2 buttons on the left are used to mute the audible alarm  and turn the internal light on or off . The arrow buttons on the right hand side are used to display the menu and navigate through and change the settings.

To enter the menu list press button 

Use buttons  and  to scroll through the menu options

To select a menu option press 

To change a setting use the  or  buttons and confirm with 

To exit from the menu or return to the previous menu screen, press the  key

The different menus are described below:

User Options Menu



The “USER OPTIONS” menu contains 4 options. These are described in more detail below.

ALARM HISTORY – The controller logs alarm events and the alarm history option is used to check the details of the alarm. For more details please refer to the ALARM HISTORY on page 12.

SENSOR TESTS – In order to avoid removing the sensors and placing them in ice etc to test the alarms, the controller physically checks the sensors in order to assure the correct operation of the temperature alarm system, by changing the resistance of the sensors in order to simulate a rise or fall in temperature.

To start the tests press the ENTER key on the “SENSOR TESTS” option then push the UP

arrow to select START and press ENTER. Exit from the menu area by pressing the  button until the load and air temperature are being displayed.

The controller will start the alarm tests. “SENSOR TESTING” is displayed in the status line. The controller will increase and decrease the load and air temperatures and the alarms will sound.

Once the tests are complete, the “SENSOR TESTING” message will disappear - the display will revert back to normal operation.

Testing the sensors does not affect the internal temperature of the appliance, nor does it operate the remote alarm terminals.

OPERATING LOG - The controller stores an operating log which records critical operating data at 5 minute intervals. The log stores data for a rolling 7 day period. To view the log press ENTER on the “OPERATING LOG” option. Use the up and down arrows to scroll through the readings.



COPY LOG TO USB – This option is used to copy the operating log to a USB memory stick. The data can then be copied to a PC and displayed using the “Heart” software package which is provided. It is recommended that the data is downloaded once a week on the same day to avoid losing any information.

To copy the file to a USB memory stick, proceed as follows:

Remove the protective USB cap.

Insert a USB memory stick.

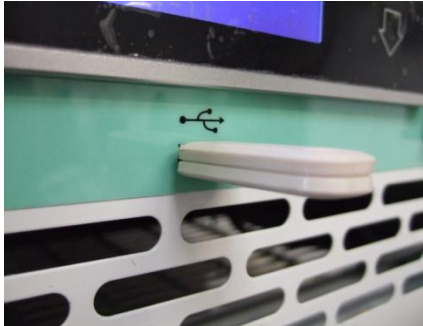

Press ENTER on the “COPY LOG TO USB” option. The controller will then begin to copy the information to the USB memory stick and display the progress as shown:

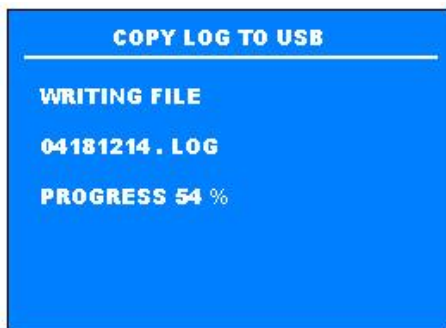

After the log file has been successfully copied, “COPY COMPLETED” is displayed. Return to the main screen by pressing the MENU key until the temperatures are displayed again.

User Settings Menu



The user settings menu gives access to settings which can be changed by the user without affecting the function of the appliance.

MUTE TIME – This setting affects the length of time that the audible buzzer is silenced for when the  button is pressed. This setting can be adjusted between 1 minute and 200 minutes. The unit is set to a default of 15 minutes as recommended in standard BS4376:1:1991.

DOOR ALARM TIME – This setting is used to change the length of time the door is open before the DOOR ALARM warning is displayed and the audible alarm starts. This setting can be adjusted between 1 minute and 10 minutes. The default setting is 1 minute.

LIGHT ON TIME – This setting changes the length of time the light stays on for, when switched on from the light button on the controller front panel. The default setting is 1 minute.

SET DATE / TIME - This option is used to set the time and date on the controller. This is pre-set for GMT. *It is important that you set the correct time and date for your location as this information is used in the alarm history and operating log.*

LANGUAGE – The language can be changed with this option. Available languages are:

English
German
French
Spanish

Technician Menu

The parameters contained in the “TECHNICIAN” menu affect the operation of the appliance and are protected by a password. These parameters are factory pre-set and should not be changed by the user. If access to these parameters is required, please call our customer service department on 0844 8153755.

Alarms and Error Messages

The controller has various status or warning messages depending on the setting or the condition of the appliance.

There are two types of alarm on the appliance:

Alert alarms

These are alarms which will require attention as soon as possible, but do not affect the immediate safety of the stored items – the refrigerator will continue to function as normal. In the case of an alert alarm, the amber light will illuminate and the cause of the alarm will be displayed in the status line.

BAT LOW – The voltage of the back-up battery for the controller and keypad is low. This may appear after a power failure, if the refrigerator has been without mains power for a length of time, or if the battery is faulty and not able to hold its charge.

DEFROST SENSOR FAIL – The sensor which controls the defrost cycle has failed. The refrigerator will continue to operate at the correct temperature but the defrost cycle may be affected.

Action alarms

These are alarms which require immediate attention – in the case of an action alarm, the buzzer will sound and the red alarm light will illuminate. The cause of the alarm is displayed in the status line. If more than one alarm occurs at once, the causes of the alarms appear alternately on the display.

The audible alarm can be silenced by pushing the  key.

DOOR ALARM – This message appears if the door is left open for longer than the user specified time period, e.g. 1 minute. The warning will clear once the door is closed.

LOAD HIGH ALARM This alarm is triggered as soon as the temperature of the load sensor in the fluid exceeds +8°C. The alarm message clears as soon as the temperature falls below +8°C.

LOAD LOW ALARM This alarm is triggered as soon as the temperature of the load sensor in the fluid falls below +2°C. The alarm message clears as soon as the temperature rises back above +2°C.

AIR HIGH ALARM This alarm is triggered once the air temperature exceeds +8°C for a period of longer than 15 minutes. The alarm message clears as soon as the air temperature falls below +8°C.

AIR LOW ALARM This alarm is triggered once the air temperature falls below +2°C for a period of longer than 15 minutes. The alarm message clears as soon as the air temperature rises above +2° C.

POWER FAIL This message appears if the mains power supply is interrupted with the appliance switched on. *Refer to power failure instruction on page 13 for more details.*

LOAD SENSOR FAIL This message appears if there is a fault with the load temperature display probe. The refrigerator will continue to operate correctly but the load temperature display will be affected.

AIR SENSOR FAIL This message appears if there is a fault with the air sensor control probe. The appliance enters a “Failsafe” running mode and control is taken over by the load sensor probe.

COMP FAIL – There is a problem with the appliance’s cooling system.

FAN FAIL – This alarm is triggered if there is a problem with the internal air circulation fan(s) – **STORED ITEMS SHOULD BE REMOVED FROM THE REFRIGERATOR IMMEDIATELY.**

Any alarm which clears from the display will be replaced by the text ‘EVENT OCCURED’, and details of the alarm will be stored in the alarm history. See “Alarm History” below.

At the occurrence of any alarm situation, attempts must be made to find out the reason for the alarm and remove it as quickly as possible. If the fault cannot be immediately identified, action should be taken so that the stored goods do not sustain any damage.

Alarm History

The controller stores details of important alarm events for:

- POWER FAILURE
- HIGH & LOW LOAD TEMPERATURE
- HIGH & LOW AIR TEMPERATURE
- DOOR ALARMS

Following the occurrence of an alarm “EVENT OCCURRED” is displayed in the status line on the control panel:



Details of the alarm can be recalled in order to check whether the stored items may have been affected.

Press the MENU key and select USER OPTIONS then ALARM HISTORY

ALARM HISTORY	
LOAD HIGH TEMP	
START	
21 - 04 - 11	15 : 32
FINISH	
21 - 04 - 11	18 : 32
EXTREME	
8 . 1 DEGREES	

Type of alarm

Start Time and Date of Alarm

End Time and Date of Alarm

In the case of a temperature alarm, the highest or lowest temperature reached is shown

Once the details of the alarm have been checked, EVENT OCCURRED will disappear from the status line on the controller. Alarm events remain stored in the controllers memory for 7 days. Use the UP and DOWN arrows to scroll through the list of alarms.

Power Fail

During a power failure, the display switches off automatically in order to save battery power, but can be switched on temporarily by pushing the  button. The display will switch off again after a short period of time.

Once mains power has been restored the refrigerator will start again automatically.

Internal Light

The appliance is fitted with an internal light.

The light will turn on automatically when the door is opened, and off when it is closed. It can also be switched on from the control panel by pressing the  button.

If the light is turned on from the control panel, it will turn off again after a period of time. The default time is 60 seconds. This can be changed in the "USER SETTINGS" menu.

Changing the fluorescent tube

Should the fluorescent tube need replacing, first turn off the power supply and remove the plug from the socket. The light cover is made from a flexible plastic. To remove it, place your thumbs on the top front face of the housing and your forefingers on the back face of the housing and gently unclip. (figure 1)

Remove the tube by turning a 1/4 turn anti clockwise and sliding the fluorescent tube out from the brackets on either side (figure 2). Replace with an equivalent T4 fluorescent tube. Slide the new tube into the fixing slots (figure 3) and secure by turning a 1/4 turn clockwise. Clip the light cover back into place. Plug in and restart the appliance.



Fig. 1



Fig.2



Fig. 3

Replacement tubes are available from our spares department. Contact details are supplied at the back of this user guide.

Remote Alarm terminals

The unit is fitted with voltage free remote alarm terminals allowing connection to an external alarm system or building management system.

In the event of a high or low temperature alarm condition or power failure a remote relay will switch within the controller to make an electrical circuit.

Under normal operating conditions with no alarm and the power on, pin 1 is connected to pin 3. In a power fail or either temperature alarm condition, or with the refrigerator switched off, pin 1 is connected to pin 2. This is illustrated below.

Note! The contacts are supplied voltage free. A voltage of between 12V DC and 24V DC, 1 Amp, can be connected at the contacts. **Hazardous voltages must not be connected to the remote alarm terminals.**

This must be installed by a competent electrician.

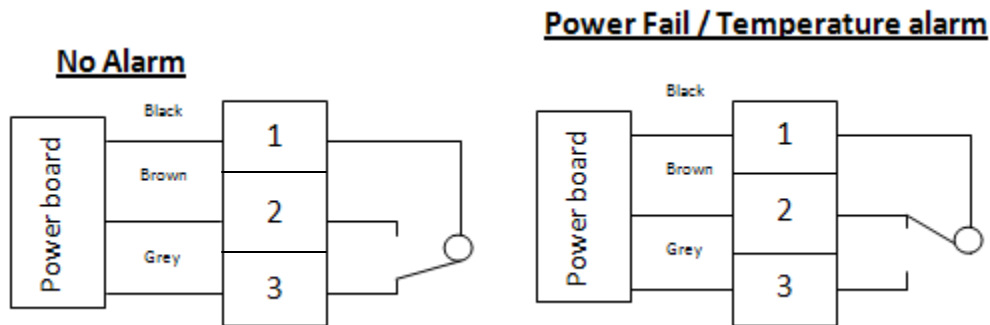

Internal Fan

All large capacity pharmacy refrigerators have internal fans fitted to ensure an even temperature throughout the storage chamber. In order to prevent warm air being drawn into the refrigerator, the fan switches off automatically when the door is opened.



It is vital that the internal fan is functioning correctly – do not block or cover the fan inlets or outlets inside the storage compartment. If the internal fan should stop working, an alarm is triggered and “FAN FAIL” will appear on the display. Any products stored in the refrigerator should be removed immediately.

Defrosting

Your appliance has an automatic defrost system which requires no special operations. The defrost water is led to the outside of the appliance via a drain into the plastic defrost water evaporation tray sitting on top of the compressor, this will evaporate and does not need emptying.

The appliance will display “DEFROSTING” when a defrost cycle is in progress. Where possible, try to avoid opening the door during this time.

Back Up Battery

All models are fitted with a rechargeable 12 volt battery. This battery is automatically charged when the appliance is connected to the mains power supply.

If the voltage of the battery should become low then the amber alarm light will flash and “BATTERY LOW” will be displayed on the status line.

When first starting up the appliance, the “BATTERY LOW” message may appear. The message will disappear as soon as the battery is charged.

The battery should be replaced every 2 years as a matter of course. This replacement must only be carried out by a service technician.



The battery is a lead-acid storage battery which must be disposed of separately.

Access Ports

A 16mm access port is fitted to the left hand side of the appliance. This can be used to feed your own monitoring probes inside the storage chamber. If you do not intend to use the port then leave the pre-fitted caps and foam insert in place.

If you intend to use the access port, remove the plastic caps and the foam insert from the access port hole. Slide the replacement plastic cap with a hole in over your probe as shown in photo 4A. Place the cable of the probe in the slit in the foam insert as shown in photo 4B. Slide the foam insert into the access port hole and push the plastic cap into place as shown in 4C.



Photo 4A

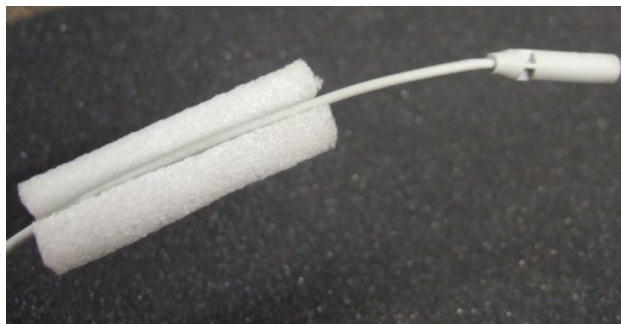

Photo 4B



Photo 4C



NEVER leave the access port open as warm air and moisture will be drawn into the refrigerator, which will affect performance.

Trouble shooting

» The appliance does not work at all

Check that the appliance is plugged in and that the power is on.

Check that the fuse in the plug is intact.

» The appliance is noisy

Check that the appliance is level.

Check that the appliance is not touching nearby items of furniture or other objects.

“Whooshing” and “gurgling” noises caused by the refrigeration system are perfectly normal and cannot be avoided.

»The appliance is not meeting the correct temperature

Check that the door is shutting and sealing correctly.

Check that the internal fan is working.

Check that the appliance is not too close to a heat source (such as a radiator).

Check that the appliance is not overloaded with products. The appliance requires space between stored items in order for the air to circulate correctly.

Check that there has not been a sudden rise or fall in room temperature. The minimum and maximum ambient operating temperatures for your appliance are listed in the table on page 2

Check that the appliance is positioned correctly. It should be positioned away from direct sunlight. There should be a minimum of 50mm clearance around the sides, 25mm at the top and 75mm of clearance at the back to allow free circulation of air.

If the ideas given above have not solved the problem, call our service centre on 0844 8153755. Do not attempt repairs on your own.

Disposal

If you are disposing of an old cabinet, break off any latches and hinges, as a safe guard against small children trapping themselves inside.

The refrigerant used in your appliance and the insulation materials require special disposal procedures in accordance with the current local regulations and laws.

Ensure that none of the pipes on the back of the appliance are damaged prior to disposal.

Details of the refrigerant can be found on the data plate.

After Sales Service

If assistance should be required please contact customer services. Give them the date of purchase, the model and serial number (found on the DATA PLATE on the outside of the appliance on the right hand side) and state the nature of the fault.

Please have as much information to hand as possible, as this will help us in assisting you.

Contact Details

Spares and After Sales Service:

E-mail: info@gdha.com

Tel: 0844 8153755

Fax: 0844 8153748

Sales:

E-mail: Sales@gdpa.co.uk

Tel: 0844 8153742

Fax: 0844 8153748

Address:

Lec Medical
Stoney Lane
Prescot
Merseyside
L35 2XW

For our full range of medical refrigerators and freezers, please visit www.lec-medical.co.uk